

DiMarzio, Inc.

1388 Richmond Terrace, PO Box 100387, Staten Island, NY 10310, Tel(718)981-9286, Fax(718)720-5296

2 HUM., 2 PUSH/PULL WIRING

(DiMarzio color code)

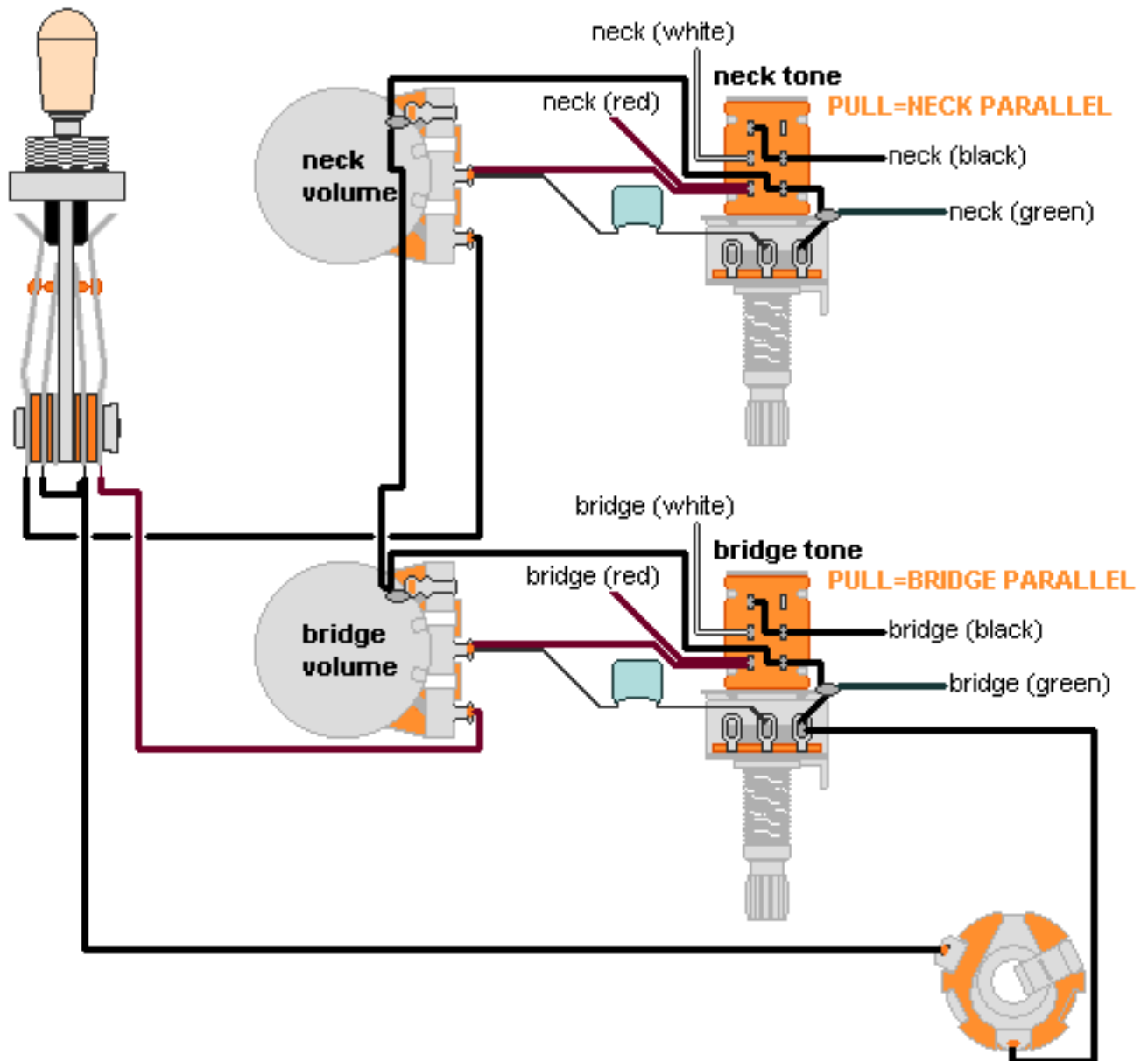

**Note: Tailpiece should be connected to common ground.
All grounds \perp must be connected.**

Copyright (C) 2003 DiMarzio, Inc. All rights reserved